

Data sheet

Differential pressure relief controller AVPA (PN 16 and PN 25)

Description



AVPA is a self-acting differential pressure relief controller primarily for use in district heating systems. The controller is normally closed and opens on rising differential pressure.

The controller has a control valve, an actuator with one control diaphragm and handle for differential pressure setting.

Main data:

- DN 15-50
- k_{vs} 4.0-25 m³/h
- PN 16, 25
- Setting range:
0.05-0.5 bar / 0.2-1.0 bar / 0.3-2.0 bar
- Temperature:
 - Circulation water / glycolic water up to 30 %: 2 ... 150 °C
- Connections:
 - External thread (weld-on, thread and flange tailpieces)
 - Flange

Ordering

Example:
Differential pressure relief controller, DN 15, k_{vs} 4.0; PN 25; setting range 0.2-1.0 bar; T_{max} 150 °C; ext. thread

- 1x AVPA DN 15 controller
Code no: **003H6602**

- Option:
- 1x Weld-on tailpieces
Code no: **003H6908**

The controller will be delivered completely assembled, inclusive impulse tubes between valve and actuator.

AVPA PN 16 Controller

Picture	DN (mm)	k_{vs} (m ³ /h)	Connection		Δp setting range (bar)	Code No.	Δp setting range (bar)	Code No.		
	15	4.0	Cylindr. ext. thread acc. to ISO 228/1	G ¾ A	0.05-0.5	003H6593	0.2-1.0	003H6596		
	20	6.3		G 1 A					003H6594	003H6597
	25	8.0		G 1¼ A					003H6595	003H6598

AVPA PN 25 Controller

Picture	DN (mm)	k_{vs} (m ³ /h)	Connection		Δp setting range (bar)	Code No.	Δp setting range (bar)	Code No.		
	15	4.0	Cylindr. ext. thread acc. to ISO 228/1	G ¾ A	0.2-1.0	003H6602	0.3-2.0	003H6605		
	20	6.3		G 1 A					003H6603	003H6606
	25	8.0		G 1¼ A					003H6604	003H6607
	32	12.5		G 1¾ A					003H6599	-
	40	16		G 2 A					003H6600	-
	50	20		G 2½ A					003H6601	-
	32	12.5	Flanges PN 25, acc. to EN 1092-2			003H6608		003H6611		
	40	20		003H6609				003H6612		
	50	25		003H6610				003H6613		

Ordering (continuous)

Accessories

Picture	Type designation	DN	Connection	Code No.
	Weld-on tailpieces	15	-	003H6908
		20		003H6909
		25		003H6910
		32		003H6911
		40		003H6912
		50		003H6913
	External thread tailpieces	15	Conical ext. thread acc. to EN 10226-1	R 1/2" 003H6902
		20		R 3/4" 003H6903
		25		R 1" 003H6904
		32		R 1 1/4" 003H6905
		40		R 1 1/2 065B2004
		50		R 2 065B2005
	Flange tailpieces	15	Flanges PN 25, acc. to EN 1092-2	003H6915
		20		003H6916
		25		003H6917

Service kits

Picture	Type designation	Δp setting range (bar)	Code No.
	Actuator with adjustable handle PN 16	0.05-0.5	003H6823
		0.2-1.0	003H6824
	Actuator with adjustable handle PN 25	0.2-1.0	003H6834
		0.3-2.0	003H6835

Technical data

Valve (for AVPA PN 16)

Nominal diameter	DN	15	20	25
k _{vs} value	m ³ /h	4.0	6.3	8.0
Cavitation factor z		≥ 0.6		
Leakage acc. to standard IEC 534	% of k _{vs}	≤ 0.2		
Nominal pressure	PN	25		
Max. differential pressure	bar	12		
Medium		Circulation water / glycolic water up to 30%		
Medium pH		Min. 7, max. 10		
Medium temperature	°C	2 ... 150		
Connections	valve	External thread		
	tailpieces	Weld-on, external thread and flange		
Materials				
Valve body		Red bronze CuSn5ZnPb (Rg5)		
Valve seat		Stainless steel, mat. No. 1.4571		
Valve cone		Dezincing free brass CuZn36Pb2As		
Sealing		EPDM		
Pressure relieve system		Piston		

Actuator (for AVPA PN 16)

Type	AVPA PN 16		
Actuator size	cm ²	39	
Nominal pressure	PN	16	
Diff. pressure setting ranges and spring colours	bar	0.05-0.5	0.2-1.0
		grey	black
Materials			
Actuator housing		Zinc plated, DIN 1624, No. 1.0338	
Diaphragm		EPDM	
Impulse tube		Copper tube Ø6 × 1 mm	

Technical data (continuous)

Valve (for AVPA PN 25)

Nominal diameter	DN	15	20	25	32	40	50
k_{vs} value	m ³ /h	4.0	6.3	8.0	12.5	16/20 ¹⁾	20/25 ¹⁾
Cavitation factor z		≥ 0.6		≥ 0.55		≥ 0.5	
Leakage acc. to standard IEC 534	% of k_{vs}	≤ 0.02			≤ 0.05		
Nominal pressure	PN	25					
Max. differential pressure	bar	20			16		
Medium		Circulation water / glycolic water up to 30 %					
Medium pH		Min. 7, max. 10					
Medium temperature	°C	2 ...150					
Connections	valve	Thread		Thread and flange			
	tailpieces	Weld-on and external thread					
		Flange		-			
Materials							
Valve body	thread	Red bronze CuSn5ZnPb (Rg5)			Ductile iron EN-GJS-400-18-LT (GGG 40.3)		
	flange	-					
Valve seat		Stainless steel, mat. No. 1.4571					
Valve cone		Dezincing free brass CuZn36Pb2As					
Sealing		EPDM					
Pressure relieve system		Piston					

¹⁾ Flange valve body

Actuator (for AVPA PN 25)

Type		AVPA PN 25	
Actuator size	cm ²	54	
Nominal pressure	PN	25	
Diff. pressure setting ranges and spring colours	bar	0.2-1.0	0.3-2.0
		yellow	red
Materials			
Actuator housing	Upper casing of diaphragm	Stainless steel, mat. No.1.4301	
	Lower casing of diaphragm	Dezincing free brass CuZn36Pb2As	
Diaphragm		EPDM	
Impulse tube		Copper tube Ø6 × 1 mm	

Application principle

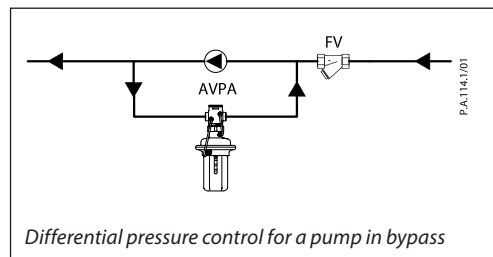

Installation positions

Up to medium temperature of 100 °C the controllers can be installed in any position.

For higher temperatures the controllers have to be installed in horizontal pipes only, with a pressure actuator oriented downwards.

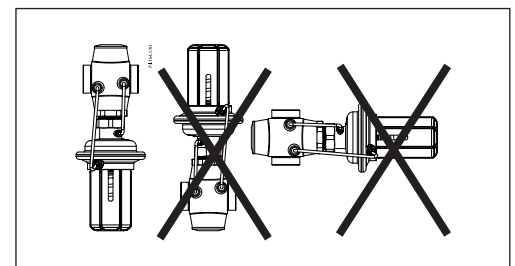
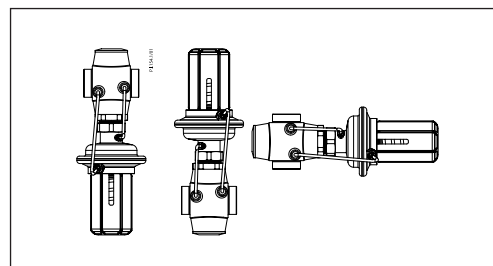

Pressure temperature diagram

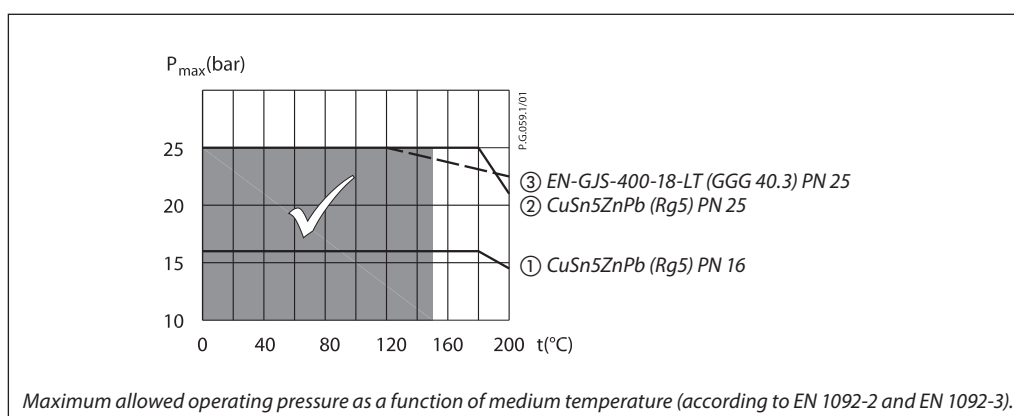

Sizing

Given data:
 $Q_{max} = 4.5 \text{ m}^3/\text{h}$
 $\Delta p_{AVPA} = 1.4 \text{ bar}$
 Nominal pressure PN 25

k_v value is calculated according to formula:

$$k_v = \frac{Q_{max}}{\sqrt{\Delta p_{AVPA}}} = \frac{4.5}{\sqrt{1.4}}$$

$k_v = 3.8 \text{ m}^3/\text{h}$

Solution:
 The example selects AVPA PN 25 DN 15,
 k_{vS} value 4.0 with differential pressure setting range 0.3-2.0 bar.

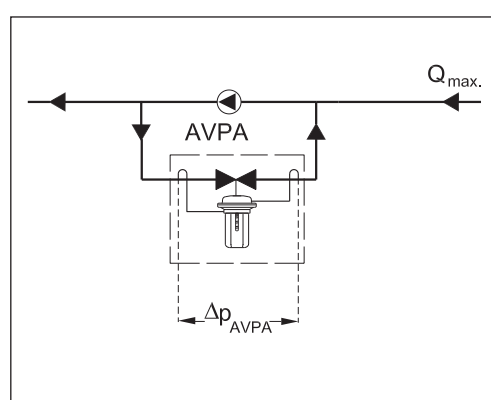

Design

1. Valve body
2. Valve insert
3. Pressure relieved valve cone
4. Valve stem
5. Control diaphragm for diff. pressure control
6. Setting spring for diff. pressure control
7. Handle for diff. pressure setting, prepared for sealing
8. Union nut
9. Upper casing of diaphragm
10. Lower casing of diaphragm
11. Impulse tube
12. Compression fitting for impulse tube
13. Actuator

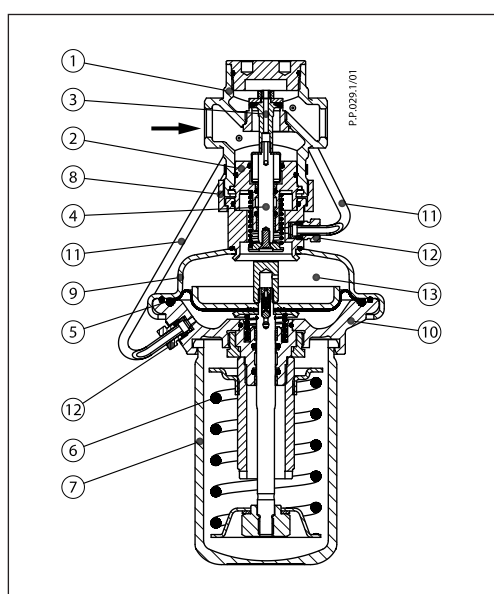

Function

The pressures in front and behind of the control valve are being transferred through the impulse tubes to the actuator chambers and act on control diaphragm. Control valve is normally closed. It opens on rising differential pressure and closes on falling differential pressure to maintain constant differential pressure.

Controller is equipped with excess pressure safety valve, which protects control diaphragm for diff. pressure control from too high differential pressure.

Settings

Differential pressure setting

Differential pressure setting is being done by the adjustment of the setting spring for differential pressure control. The adjustment can be done by means of spring for differential pressure setting and/or pressure indicators

Adjustment

Relation between scale figures and differential pressure. Values given are approximate.

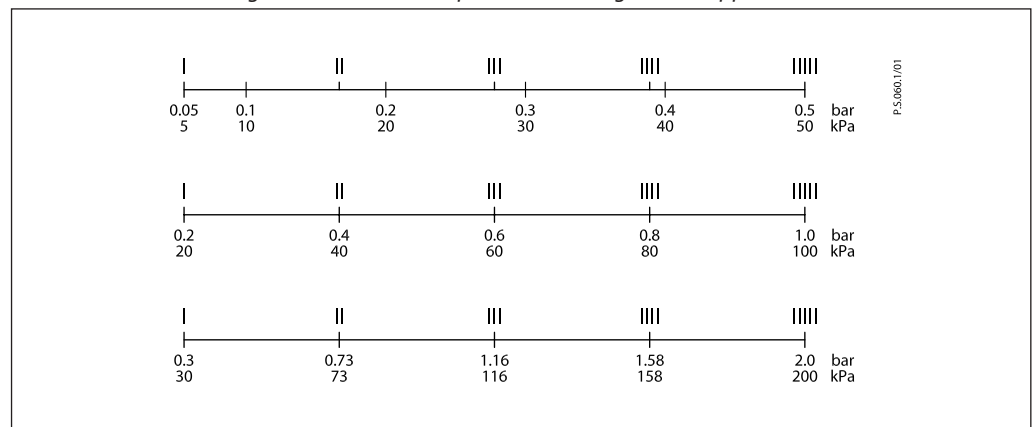

Dimensions

