

Data Sheet

Infocal 9

Energy calculator

Description/Application

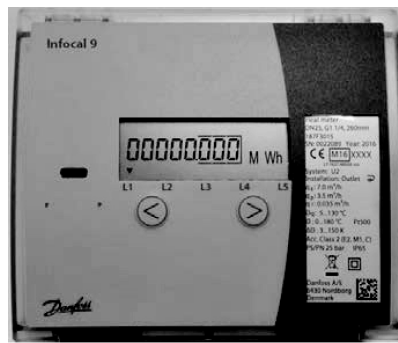

MID examination certificate no.: LT-1621-MI004-028

The INFOCAL 9 is an energy calculator, e.g. for combination with SONO 3500 CT or SonoSensor 30. It is especially designed for heating, cooling or combined heating/cooling applications in local and district energy systems.

The INFOCAL 9 has been approved according to MID in accuracy class 2. The calculators are designed for remote read-out (AMR).

Features

- For heating and cooling application
- Battery or 230 V AC power supply
- Lithium battery with 12 years lifetime
- Pair of Pt 500 temperature 2-wire sensors included
- For 2- and 4-wire temperature sensors
- Temperature range: 0 to +160 °C
- Remote reading via M-Bus, radio OMS 868, 2 x pulse output, 2 x 4-20 mA output
- Two pulse inputs integrated as standard
- Calculator with IP65 protection class as standard
- For return or supply pipe flow sensor or flow meter installation
- Individual tariff functions
- History memory for 32 months
- Suitable for Danfoss ECL Comfort controller
- Special option with 2 flow sensors, 2 pressure sensors and 3 temperature sensors measurement

Application drawings

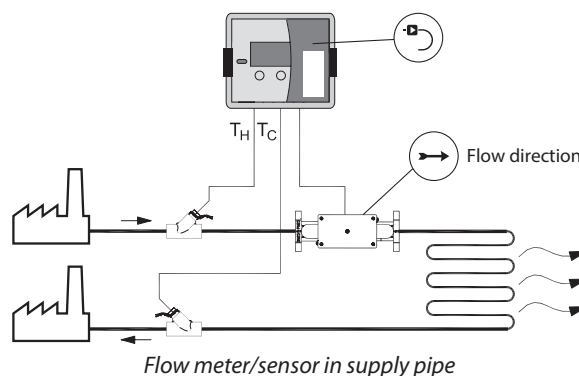
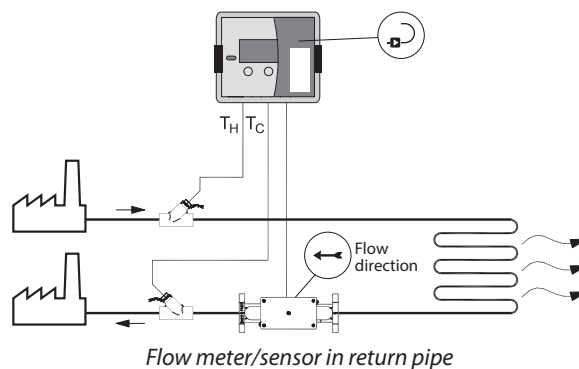

Ordering Infocal 9

Primarily for flow meter/sensor	Pulse value	Installation	Power supply	Energy units	Communication	Cable length ¹⁾	Code number
SONO 3500 CT (DN100-DN150)	2,5 liter / pulse	Return	Battery	0,01 MWh	M-Bus	3m	187F9007
SONO 3500 CT (DN200-DN350)	10 liter / pulse	Return	Battery	0,01 MWh	M-Bus	5m	187F9008
SONO 3500 CT (DN400-DN500)	50 liter / pulse	Return	Battery	0,01 MWh	M-Bus	5m	187F9009
SONO 3500 CT (DN600-DN1200)	100 liter / pulse	Return	Battery	0,01 MWh	M-Bus	5m	187F9010
SONO 3500 CT (DN100-DN150)	2,5 liter / pulse	Return	230V AC	0,01 MWh	M-Bus	3m	187F9011
SONO 3500 CT (DN200-DN350)	10 liter / pulse	Return	230V AC	0,01 MWh	M-Bus	5m	187F9012
SONO 3500 CT (DN400-DN500)	50 liter / pulse	Return	230V AC	0,01 MWh	M-Bus	5m	187F9013
SONO 3500 CT (DN600-DN1200)	100 liter / pulse	Return	230V AC	0,01 MWh	M-Bus	5m	187F9014
SonoSensor 30 (DN15 - DN25)	1 liter / pulse	Return	Battery	0,001 MWh	M-Bus	2m	187F9000
SonoSensor 30 (DN40 - DN100)	10 liter / pulse	Return	Battery	0,01 MWh	M-Bus	3m	187F9001

¹⁾ Cable length of Pt 500, Ø 5.2 mm, 2-wire temperature sensor.

Ordering accessories

Product	Designation	Quantity	Code no.
Power supply	Battery 3.6 V DC (D-cell)	1 pc.	187F3380
Power supply	Mains unit 230 V AC	1 pc.	187F3381
Communication module	M-Bus module	1 pc.	187F3382
Communication module	Radio OMS 868.95 MHz	1 pc.	187F3383
Communication module	RS-232 M-Bus	1 pc.	187F3385
Communication module	RS-485 M-Bus ¹⁾	1 pc.	187F3386
Communication module	M-Bus, RS232 and two pulses outputs ¹⁾	1 pc.	187F3387
Communication module	M-Bus, RS232 and two 4-20mA outputs ¹⁾	1 pc.	187F3388
Temperature sensor	Pt 500 / f 5.2 mm / 1.5 m cable, MID	1 pair	187F3125
Temperature sensor	Pt 500 / f 5.2 mm / 2 m cable, MID	1 pair	187F3126
Temperature sensor	Pt 500 / f 5.2 mm / 3 m cable, MID	1 pair	187F3127
Temperature sensor	Pt 500 / f 5.2 mm / 5 m cable, MID	1 pair	187F3390
Temperature sensor	Pt 500 / f 5.2 mm / 10 m cable, MID	1 pair	187F3391
Sensor pockets	Ø 5.2 mm, brass, 35 mm length	1 pair	087G6053
Sensor pockets	Ø 5.2 mm, brass, 52 mm length	1 pair	087G6054
Sensor pockets	Ø 5.2 mm, brass, 85 mm length	1 pair	087G6055
Sensor pockets	Ø 5.2 mm, brass, 120 mm length	1 pair	087G6056
Sensor pockets	Ø 5.2 mm, stainless steel, 85 mm length	1 pair	087G6057
Sensor pockets	Ø 5.2 mm, stainless steel, 120 mm length	1 pair	087G6058
Sensor pockets	Ø 5.2 mm, stainless steel, 155 mm length	1 pair	087G6059
Sensor pockets	Ø 5.2 mm, stainless steel, 210 mm length	1 pair	087G6060

¹⁾ Only with mains supply 230 V AC

Technical data

Basic data	Accuracy	Class 2, EN1434	
	Ambient	Class E2 +M1	
	Environmental	Class C EN1434	
	Protection class	IP 65	
	Max. ambient humidity	93% rel. humidity	
Display indication	Display	LCD, 8-digit	
	Units	MWh - GJ - Gcal - °C - m ³ - m ³ /h	
	Values displayed	Energy , volume, power, flow rate , temperatures	
Temperature	Ambient operating temperature	[C°]	+5 ... +55
Input	Temperature sensors	Type	Pt 500 with 2 or 4-wire leads; Ø 5.2 or Ø 6.0 mm
	Measuring cycle	T[s]	Temperature: 10s (for both battery and 230 V supply)
	Max. temperature difference	Δθmax [K]	160
	Min. temperature difference	Δθmin [K]	3
	Starting temp. difference	Δθ [K]	0.15 K
	Temperature, measuring range	θ [°C]	0 ... 160
Supply voltage	3.6 V DC Lithium-battery (D-cell) or Mains supply 230 V AC		
Battery life time	min. 12 years (including AMR communication)		
Weight	0.5 kg		

Design and function

Calculator

The calculator contains all necessary circuits for recording flow rates and temperatures, and for calculating, logging and displaying the data. The calculator housing can be mounted on the wall or standard DIN rail. The calculator can be conveniently read from an 8-digit display with units and symbols. Two push-buttons provides user-friendly control of the various display loops. All failures and faults are recorded automatically and shown on LCD display. To protect the reading data, all relevant data are saved in a non-volatile memory (EEPROM). This memory saves the measured values, device parameters and types of error at regular intervals.

Temperature sensors

Pairs of Pt 500 Ø5.2 mm (or Ø6.0 mm) temperature sensors with 2-wire (or 4-wire) leads can be used. Cable lengths of 3 m, 5 m and 10 m are available.

Optical interface

Optical interface is integrated into the front panel of the calculator. It is designed for data reading via M-bus protocol. The optical interface is activated by pressing the control button, and it automatically shuts off 5 minutes after the button has been activated or after data transmission via interface is completed.

Wired M-Bus interface

The energy meter has one slot for an additional communication module. The internal M-Bus module provides data reading possibility via M-Bus protocol:

- M-Bus protocol according to EN13757-3 standard
- 2-wire with polarity reversal protection
- Electrical isolation
- Maximum voltage 50 V DC
- Current drawn: one M-Bus load (1.5 mA)
- Primary or secondary addressing
- Baud rate 300/1200/2400/4800/9600 (default: 2400 baud rate)
- Battery lifetime min. 12 years (D cell)
- Fastest reading interval at battery supply: one meter on the bus every 280 seconds (2400 baud rate)
- Fastest reading interval at mains supply: no limits

Radio OMS 868.95 MHz interface

The module can provide data reading via radio module:

- Wireless M-Bus protocol according to EN13757-4
- OMS (open metering system) compatible
- 868.95 MHz, T1 mode (unidirectional)
- Sending interval every 90 seconds (suitable for 'walk by' readings)

Pulse inputs

Number of pulse inputs	2
Measurement units	m ³
Pulse value	Configurable by control buttons
Min. pulse time	100 ms
Pulse type	IB by LST EN1434-2
Max. frequency of input pulses	5 Hz
Max. voltage of input pulses	3.6 V

Data logger

Data logger

Daily, weekly and monthly parameter values and errors are recorded in heat meter memory.

Retention time of measured integrated parameters even if device is disconnected from power supply not more than 12 years.

Data logger capacity

- up to 110 days (3.5 months) – for hourly records
- up to 1461 days (36 latest months) - for daily and monthly records

Power supply

Power supply (one of following depending on meter configuration):

- 1 D-cell battery 3.6 V DC, 19 Ah (ER 34615) lithium battery, life time at least 12 years.
- Mains power supply 230 V AC 50 (+/- 2 Hz)

Display symbols

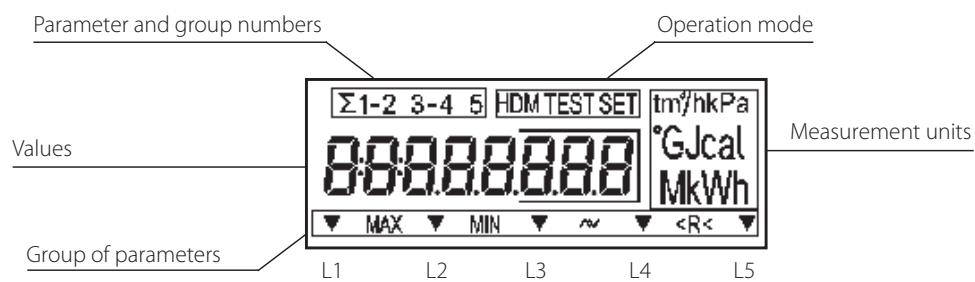

Display menu structure

Parameters shown	Identification symbols				
Integral values (L1)	▼				
	L1	L2	L3	L4	L5
Instantaneous parameters values (L2)		▼			
	L1	L2	L3	L4	L5
Set day parameters and archive data values (L3)			▼		
	L1	L2	L3	L4	L5
Printing reports by standard printer (L4)				▼	
	L1	L2	L3	L4	L5
Configuration settings parameters (L5)					▼
	L1	L2	L3	L4	L5
Parametrization (configuration) mode (SET)			SET		
	L1	L2	L3	L4	L5
Test mode (TEST)			TEST		
	L1	L2	L3	L4	L5

Dimensions

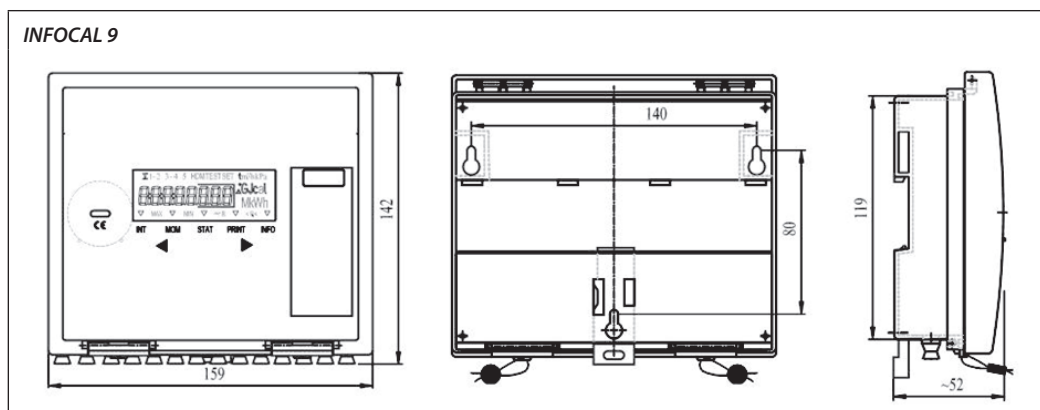

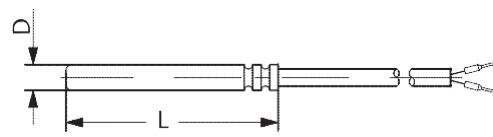
Temperature sensors 	Installation	Type	Diameter D (MM)	Length L (MM)
	Immersed (direct) or in pocket (indirect)	Pt 500	Ø5.2	45

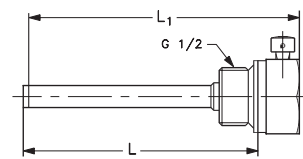
Sensors pockets 	Type		Brass				Stainless steel			
	Sensor diameter	(mm)	Ø 5.2				Ø 5.2			
Length	L1 (mm)		47	60	93	128	98	133	168	223
	L (mm)		35	52	85	120	85	120	155	210

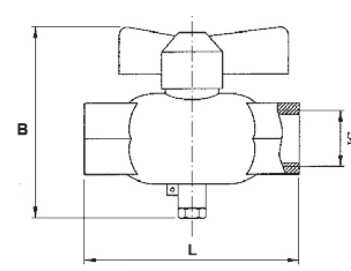
Ball valves 	Dimension IG (mm)	Length L (mm)	Height B (mm)
	G1/2"	48	77
	G3/4"	54	79
	G1"	66	96

ENGINEERING
TOMORROW



Danfoss A/S

Energy Meters • Ulvehavevej 61 • DK-7100 Vejle • Denmark

Phone: +45 7488 8500 • Fax: +45 7488 8501

heating@danfoss.com • www.heating.danfoss.com

Danfoss can accept no responsibility for possible errors in catalogues, brochures and other printed material. Danfoss reserves the right to alter its products without notice. This also applies to products already on order provided that such alterations can be made without subsequential changes being necessary in specifications already agreed.
All trademarks in this material are property of the respective companies. Danfoss and the Danfoss logotype are trademarks of Danfoss A/S. All rights reserved.
