

Operating Guide

ECA 30 / 31 for ECL Comfort 210 / 210B / 296 / 310 / 310B



1.0 Table of Contents

1.0 Table of Contents	1
2.0 User Guide.....	2
2.1 Symbol overview	2
2.2 Introduction	4
2.3 Display information ECA 30 / 31.....	5
2.4 Override functions ECA 30 / 31	10
3.0 Installation	11
3.1 Important safety and product information.....	11
3.2 Mounting	15
3.3 Placing the temperature sensors.....	16
3.4 Electrical connections.....	17
3.5 ECA 30 / 31 setup procedures	20
4.0 Settings.....	28
4.1 Room temperature	28
4.2 Optimization.....	29
4.3 Holiday	30

2.0 User Guide

2.1 Symbol overview

ECA 30 / 31 for ECL Comfort 210 / 210B / 296 / 310 / 310B

2.1.1 A general overview: What do the symbols mean?

Symbol	Description	
	Outdoor temp.	Temperature
	Relative humidity indoor	
	Room temp.	
	DHW temp.	
	Position indicator	
	Scheduled mode	Mode
	Comfort mode	
	Saving mode	
	Frost protection mode	
	Manual mode	
	Standby	
	Cooling mode	
	Active output override	
	Optimized start or stop time	
	Heating	Circuit
	Cooling	
	DHW	
	Common controller settings	
	Pump ON	Controlled component
	Pump OFF	
	Fan ON	
	Fan OFF	
	Actuator opens	
	Actuator closes	
	Actuator, analogue control signal	
	Pump / fan speed	
	Damper ON	
	Damper OFF	

Symbol	Description
	Alarm
	Letter
	Event
	Monitoring temperature sensor connection
	Display selector
	Max. and min. value
	Trend in outdoor temperature
	Wind speed sensor
	Sensor not connected or not used
	Sensor connection short-circuited
	Fixed comfort day (holiday)
	Active influence
	Heating active (+) Cooling active (-)
	Number of heat exchangers

Additional symbols, ECA 30 / 31:

Symbol	Description
	ECA Remote Control Unit
	Connection address (master: 15, slaves: 1 - 9)
	Day off
	Holiday
	Relaxing (extended comfort period)
	Going out (extended saving period)

In ECA 30 / 31 only the symbols that are relevant to the application in the controller are displayed.

ECA 30 / 31 for ECL Comfort 210 / 210B / 296 / 310 / 310B

2.2 Introduction

The Remote Control Units (RCU) ECA 30 and ECA 31 are used for room temperature control and override of the ECL Comfort 210 / 210B, ECL Comfort 296 and ECL Comfort 310 / 310B controllers.

Up to two remote control units can be connected to one ECL controller in order to control the ECL controller remotely. The display has backlight.

The RCUs are connected to the ECL Comfort controllers by means of 2 × twisted pair cables for communication and power supply (ECL 485 communication bus).

The ECA 30 / 31 has a built-in room temperature sensor. An external room temperature sensor can be connected substituting the built-in temperature sensor.

Furthermore, the ECA 31 has a built-in relative humidity sensor and the signal is used in relevant applications.

It is possible to connect up to 2 RCUs on the ECL 485 communication bus.

One RCU can monitor max. 10 ECL Comfort controllers (master/slave system).

Please consult the user guide that is enclosed with your product for more information on the ECL Comfort controller.

ECA 30 (code no. 087H3200)	Remote control unit with room temperature sensor
ECA 31 (code no. 087H3201)	Remote control unit with room temperature sensor and relative humidity sensor



Safety Note

To avoid injury of persons and damages to the device, it is absolutely necessary to read and observe these instructions carefully.

Necessary assembly, start-up, and maintenance work must be performed by qualified and authorized personnel only.

Local legislations must be respected. This comprises also cable dimensions and type of isolation (double isolated at 230 V).

A fuse for the ECL Comfort installation is max. 10 A typically.

The ambient temperature ranges for ECL Comfort in operation are:

ECL Comfort 210 / 310: 0 - 55 °C

ECL Comfort 296: 0 - 45 °C.

Exceeding the temperature range can result in malfunctions.

Installation must be avoided if there is a risk for condensation (dew).

The warning sign is used to emphasize special conditions that should be taken into consideration.



This symbol indicates that this particular piece of information should be read with special attention.

ECA 30 / 31 for ECL Comfort 210 / 210B / 296 / 310 / 310B

2.3 Display information ECA 30 / 31

2.3.1 How to navigate

The display and the dial are used in the same way as in the ECL Comfort Controller.

You navigate in the controller by turning the dial left or right to the desired position (◂◃).

The dial has a built-in accelerator. The faster you turn the dial, the faster it reaches the limits of any wide setting range.

The position indicator in the display (▶) will always show you where you are.

Push the dial to confirm your choices (⏏).

The display examples are from an ECA 30 and an ECA 31. The examples might differ from your application.

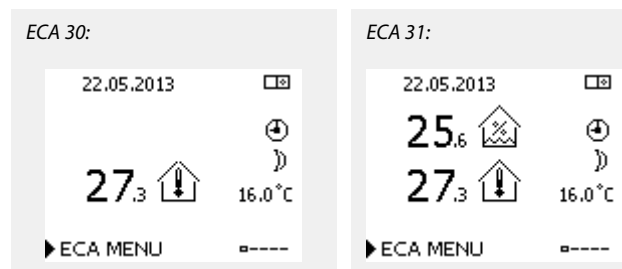
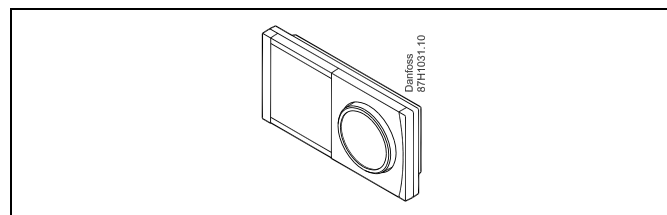

2.3.2 ECA 30 / 31, display information

The controller icon has an address indication of the connected ECL Comfort controller.

To change connection address:

1. Choose ECA picture
2. Move the position indicator to the controller icon
3. Push the dial to select the controller icon
4. Turn the dial to select desired address
5. Push the dial to confirm your choice

Example showing connected ECL Comfort Controller address.

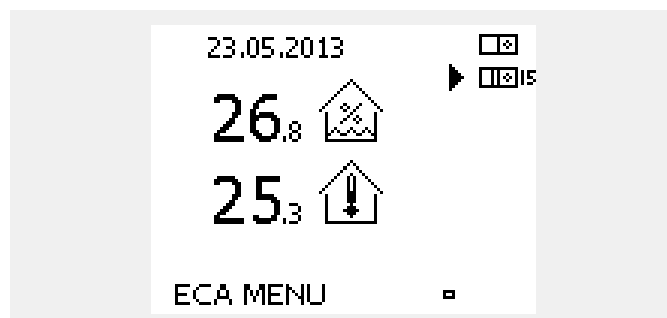

2.3.3 Pop-up: Copy new application, YES / NO

The first time an ECA 30 / 31 connects to an ECL Comfort controller with a new application or a known application with a new language, the ECA 30 / 31 asks to copy the application and language to the ECA 30 / 31.

Proper communication is not possible before the application has been copied.

NO: The application will not be copied to the ECA 30 / 31.

YES: The application will be copied to the ECA 30 / 31.

Typically, the selection is "YES".

"NO" is selected when some of several ECL Comfort controllers in an ECL 485 bus system should not be copied to the ECA 30 / 31.



When starting the ECA 30 / 31 for the first time, the reaction time seems slow. Normal reaction time is achieved when the application has been copied to the ECA 30 / 31.

ECA 30 / 31 for ECL Comfort 210 / 210B / 296 / 310 / 310B

2.3.4 Situation: Copying

The application, for example A266.1, is copied to the ECA 30 / 31.

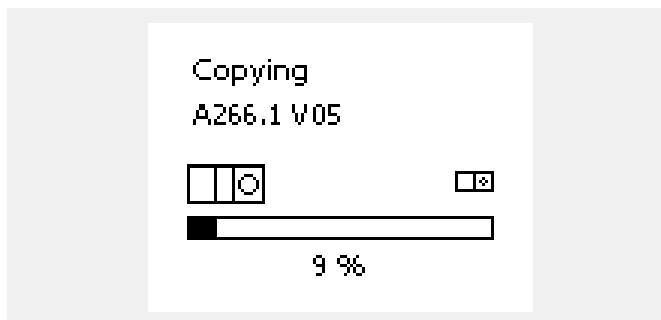

The copied application is saved in the ECA 30 / 31. Hereby the application does not need to be copied again the next time the ECA 30 / 31 connects to the same ECL Comfort controller. Up to 10 applications can be saved.

2.3.5 Pop-up: Application requires newer ECA

This pop-up message indicates that the application cannot run in the ECA 30 / 31 because new improvements have been made.

An ECA 30 / 31 must have the version 1.39 as a minimum in order to be updated from an application key.

In this example 1.30 is current version and 1.40 or newer is desired version.



Situation:

The ECA 30 / 31 will display this information (an X on the ECA 30 / 31 symbol) if the application in the ECL controller does not comply with the ECA 30 / 31.



In this example 1.10 is current version and 1.42 is desired version.

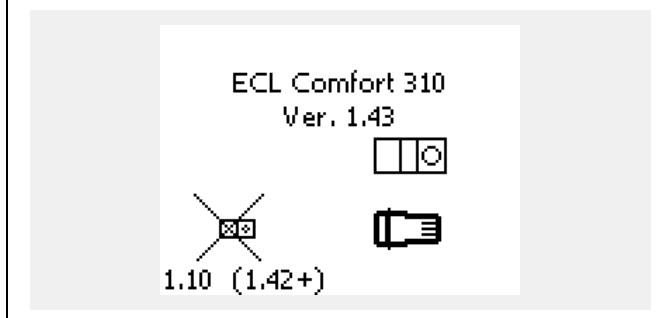

ECA 30 / 31 for ECL Comfort 210 / 210B / 296 / 310 / 310B

2.3.6 Situation: ECA MENU point only

This display indicates that an application has not been uploaded or the communication to the connected ECL controller is not working properly.

An X on the ECL controller symbol indicates that there is no communication with a master on the ECL485 bus network.

Help procedure:

1. Check wiring connections between ECA 30 / 31 and ECL Comfort controller
2. Check communication address:

In ECL Comfort: MENU > Common controller settings > System > Communication > ECL 485 addr.:

As standard "15" is selected.

In ECA 30 / 31: ECA MENU > ECA System > ECA Communication > Connection addr.:

As standard "15" is selected.

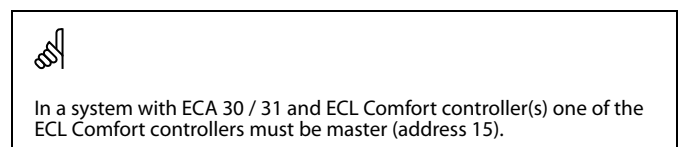
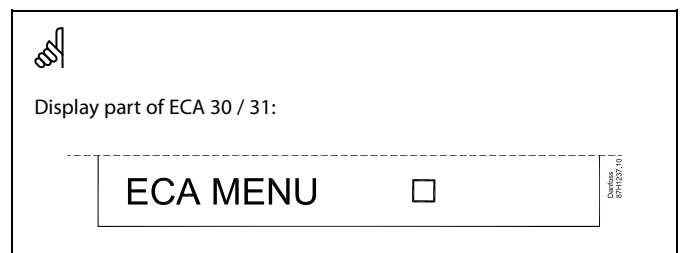
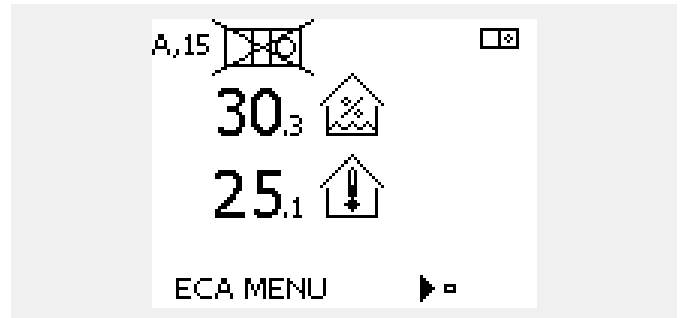

ECA 30 / 31 for ECL Comfort 210 / 210B / 296 / 310 / 310B

2.3.7 Situation: ECA picture - Date and room temperature

In the ECA picture the date is shown. Some applications show the room temperature too.

Mode selector and desired room temperature are not shown.



The ECA 30 / 31 is not set up to communicate with a heating circuit in the connected ECL controller.
See the example for establishing the desired communication.

2.3.8 Override

The ECA 30 / 31 is not factory set up to communicate with a heating circuit in the connected ECL controller.

In order to arrange temporarily override, the ECA 30 / 31 must be set up to communicate with the desired heating circuit in the ECL Comfort controller.

See the following examples for establishing the desired communication.

Example:

ECL Comfort:

Circuit 1 > MENU > Settings > Application:

ECA addr.: Set to A

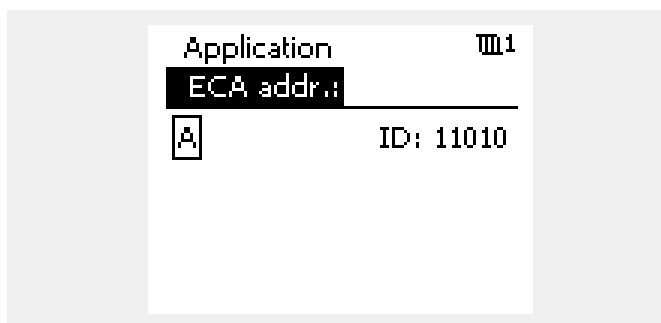

ECA 30 / 31 for ECL Comfort 210 / 210B / 296 / 310 / 310B

Example, continued:

ECA 30 / 31:

ECA MENU > ECA System > ECA communication:

Connection addr.:

- Set to 15 (only one controller, the master, in the system)
- Set to 1 ... 9 or 15 (when master and slave(s) controllers in the system)

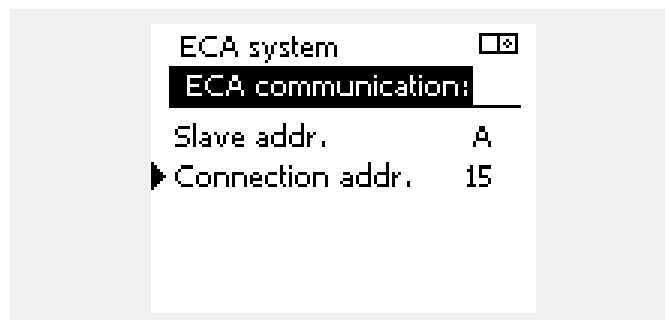

Alternative setting of address:

1. Choose ECA picture
2. Move the position indicator to the controller icon
3. Push the dial to select the controller icon
4. Turn the dial to select desired address
5. Push the dial to confirm your choice

Example showing connected ECL Comfort Controller address.

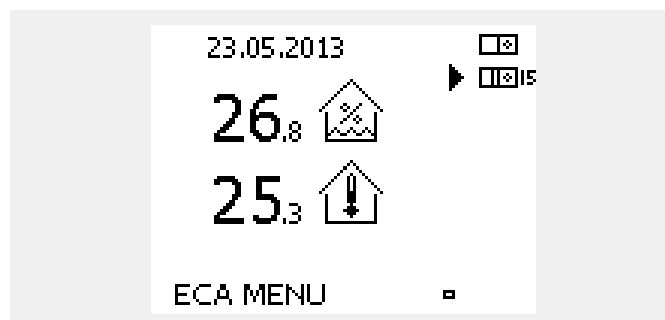

Example, continued:

ECA 30 / 31:

ECA MENU > ECA System > ECA override:

Override addr.:

- Set to 15 (only one controller, the master, in the system)
- Set to 1 ... 9 or 15 (when master and slave(s) controllers in the system)

Override circuit:

- Set the desired circuit number (1-4).

Note:

- Only heating circuits can be overridden.
- In the ECL Comfort controller the heating circuit in question must be set to A or B.

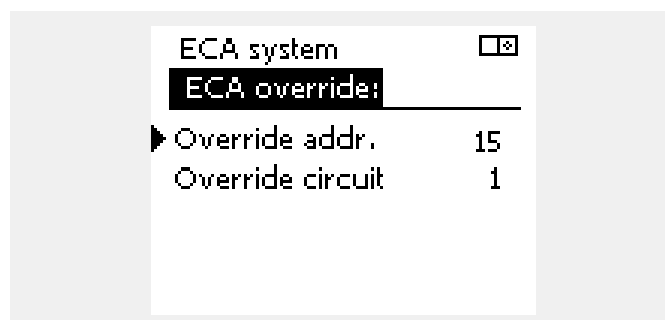

ECA 30 / 31 for ECL Comfort 210 / 210B / 296 / 310 / 310B

2.4 Override functions ECA 30 / 31

The table to the right shows the override functions.

The override functions are enabled when communication has been established (see ECA MENU > ECA system > ECA override).

Furthermore, the function selector of the heating circuit must be in scheduled mode.

If holiday mode is activated then holiday mode takes priority and cancels the override mode.

Override functions:	Extended saving mode:	
	Extended comfort mode:	
	Holiday away from home:	
	Holiday at home:	



DHW circuits cannot be temporarily overridden.

Example on override:

- Go to ECA MENU
- Place cursor at clock symbol (Function selector)
- Push / turn dial to select override form



If scheduled mode is not selected, the cursor cannot be placed at the function selector.

Extended saving mode :

When selected, the override stop time can be set (max. 23 hours ahead).

In addition, the desired room temperature in the override period can be set.

Extended comfort mode :

When selected, the override stop time can be set (max. 23 hours ahead).

In addition, the desired room temperature in the override period can be set.

Holiday away from home :

When selected, the override stop date can be set (max. 365 days ahead).

In addition, the desired room temperature in the override period can be set.

Holiday at home :

When selected, the override stop date can be set (max. 365 days ahead).

In addition, the desired room temperature in the override period can be set.



When "holiday" override is selected, the stop date is the last holiday date.

Example:

Stop date is set to "15.11" (15th of November), meaning that from midnight between the 15th of November and the 16th of November, the override is disabled.

ECA 30 / 31 for ECL Comfort 210 / 210B / 296 / 310 / 310B

3.0 Installation

3.1 Important safety and product information

3.1.1 Important safety and product information

This Installation Guide is associated with the Remote Control Units ECA 30 (code no. 087H3200) and ECA 31 (code no. 087H3201).

ECA 30 is a remote control unit with room temperature sensor.
ECA 31 is a remote control unit with room temperature sensor and relative humidity sensor.

ECA 30 and ECA 31 can be used with ECL Comfort 210 / 210B, ECL Comfort 296 and ECL Comfort 310 / 310 B controllers.

For information on general functions please consult the installation guide for the application key in question.

Additional documentation for ECL Comfort 210 and 310, modules and accessories is available on www.ecl.doc.danfoss.com.



Safety Note

To avoid injury of persons and damages to the device, it is absolutely necessary to read and observe these instructions carefully.

Necessary assembly, start-up, and maintenance work must be performed by qualified and authorized personnel only.

Local legislations must be respected. This comprises also cable dimensions and type of isolation (double isolated at 230 V).

A fuse for the ECL Comfort installation is max. 10 A typically.

The ambient temperature ranges for ECL Comfort in operation are:

ECL Comfort 210 / 310: 0 - 55 °C

ECL Comfort 296: 0 - 45 °C.

Exceeding the temperature range can result in malfunctions.

Installation must be avoided if there is a risk for condensation (dew).

The warning sign is used to emphasize special conditions that should be taken into consideration.



This symbol indicates that this particular piece of information should be read with special attention.



As this Operating Guide covers several system types, special system settings will be marked with a system type. All system types are shown in the chapter: 'Identifying your system type'.



°C (degrees Celsius) is a measured temperature value whereas K (Kelvin) often is used for temperature differences.



The ID no. is unique for the selected parameter.

Example	First digit	Second digit	Last three digits
11174	1	1	174
	-	Circuit 1	Parameter no.
12174	1	2	174
	-	Circuit 2	Parameter no.

If an ID description is mentioned more than once, it means that there are special settings for one or more system types. It will be marked with the system type in question (e.g. 12174 - A266.9).



Parameters indicated with an ID no. like "1x607" mean a universal parameter.

x stands for circuit / parameter group.



Disposal Note

This product should be dismantled and its components sorted, if possible, in various groups before recycling or disposal.

Always follow the local disposal regulations.

ECA 30 / 31 for ECL Comfort 210 / 210B / 296 / 310 / 310B

3.1.2 Update of ECA 30 / 31 software

The firmware of the ECA 30 / 31 can be automatically updated when a key containing new ECA 30 / 31 firmware is inserted in the ECL Comfort controller and the controller has not yet got an application installed.

Both the ECL Comfort controller and the ECA 30 / 31 must have software version 1.39 or higher.

The ECA 30 / 31 firmware update can also be started manually by using the update firmware menu in the ECA 30 / 31 during normal operation.

The new firmware must be copied to the ECA 30 / 31 unit before it can be applied.

During the copy process an animation showing the progress will be shown.

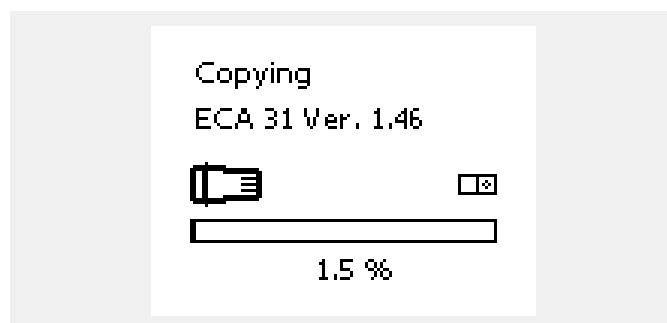

When the new firmware has been copied to the ECA 30 / 31 the copy process will end with this picture.

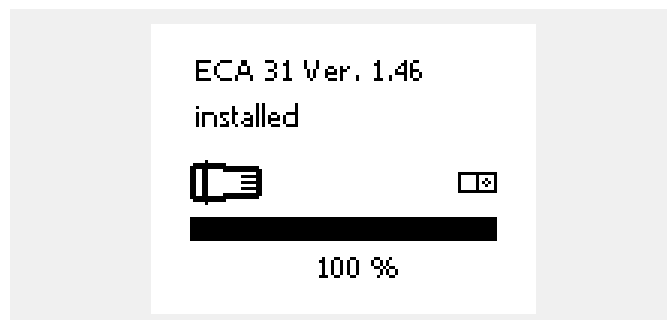

After the new firmware has been copied to the ECA 30 / 31 unit it will update the device itself while showing an hour-glass and a progress bar.

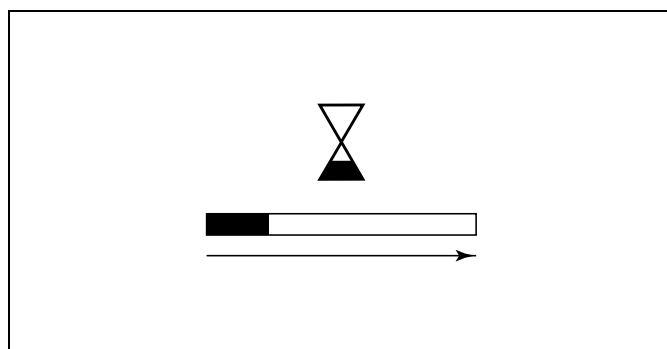



During update:

- Do not remove the KEY
If the key is removed before the hour-glass is shown, you have to start afresh.
- Do not disconnect the power
If the power is interrupted when the hour-glass is shown, the controller will not work.

ECA 30 / 31 for ECL Comfort 210 / 210B / 296 / 310 / 310B

3.2 Mounting

3.2.1 Mounting the Remote Control Units ECA 30 / 31

Select one of the following methods:

- Mounting on a wall, ECA 30 / 31
- Mounting in a panel, ECA 30

Screws and rawlplugs are not supplied.

Mounting on a wall

Mount the base part of the ECA 30 / 31 on a wall with a smooth surface. Establish the electrical connections. Place the ECA 30 / 31 in the base part.

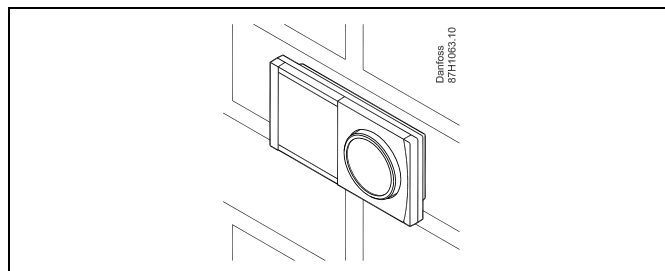

Mounting in a panel

Mount the ECA 30 in a panel using the ECA 30 frame kit (order code no. 087H3236). Establish the electrical connections. Secure the frame with the clamp. Place the ECA 30 in the base part. The ECA 30 can be connected to an external room temperature sensor.

The ECA 31 must not be mounted in a panel if the humidity function is to be used.

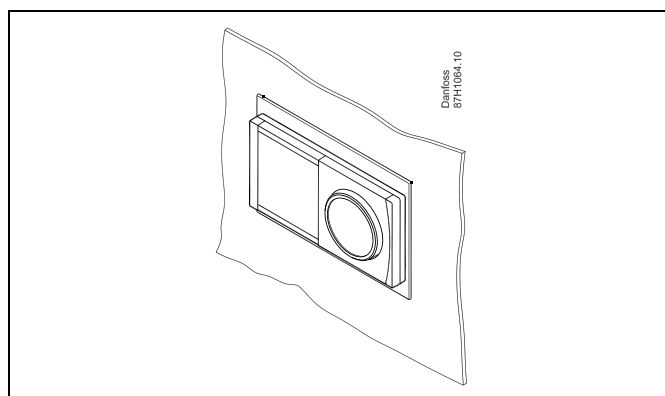

ECA 30 / 31 for ECL Comfort 210 / 210B / 296 / 310 / 310B

3.3 Placing the temperature sensors

Room temperature sensor (ESM-10, ECA 30 / 31 Remote Control Unit)

Place the room sensor in the room where the temperature is to be controlled. Do not place it on outside walls or close to radiators, windows or doors.

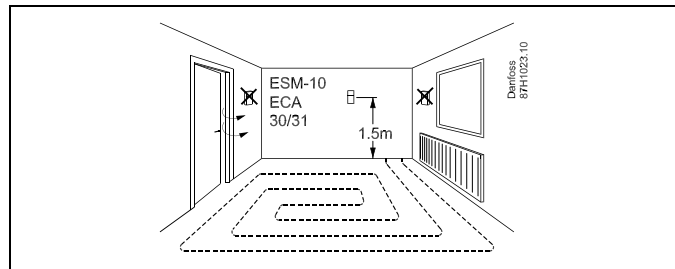

3.4 Electrical connections

ECA 30 / 31 for ECL Comfort 210 / 210B / 296 / 310 / 310B

3.4.1 Electrical connections, ECA 30 / 31

Terminal ECL	Terminal ECA 30 / 31	Description	Type (recomm.)
30	4	Twisted pair	Cable 2 x twisted pair
31	1		
32	2	Twisted pair	
33	3		
	4	Ext. room temperature sensor*	ESM-10
	5		

* After an external room temperature sensor has been connected, ECA 30 / 31 must be repowered.

The communication to the ECA 30 / 31 must be set up in the ECL Comfort controller in 'ECA addr.'

The ECA 30 / 31 must be set up accordingly.

After application setup the ECA 30 / 31 is ready after 2–5 min. A progress bar in the ECA 30 / 31 is displayed.

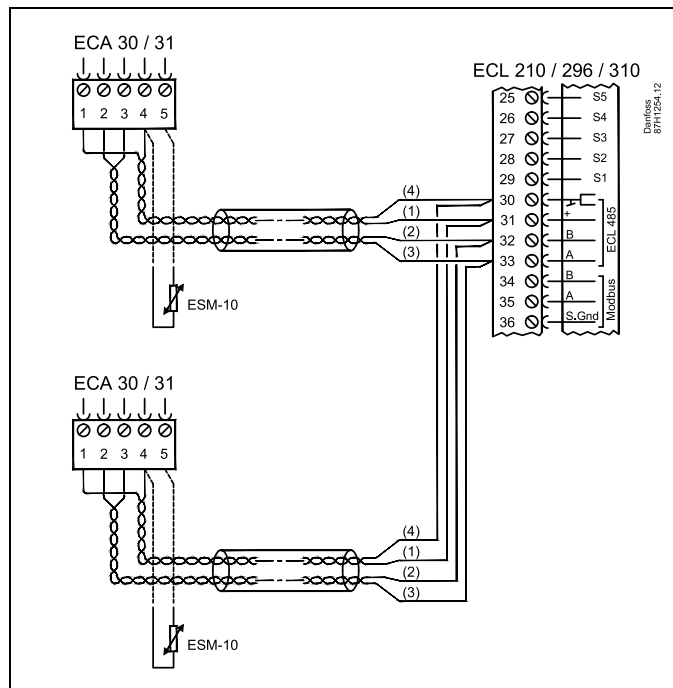
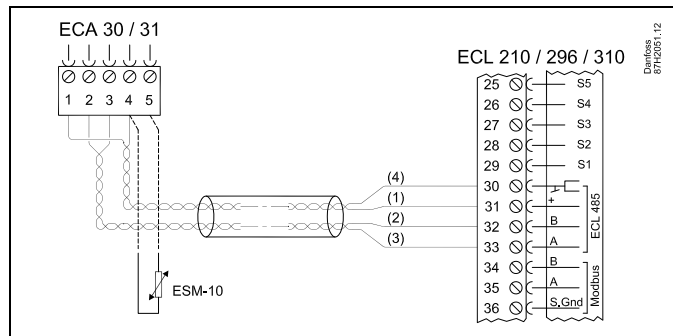

If the actual application contains two heating circuits, it is possible to connect an ECA 30 / 31 to each circuit. The electrical connections are done in parallel.



Max. 2 ECA 30 / 31 can be connected to an ECL Comfort 310 controller or to ECL Comfort 210 / 296 / 310 controllers in a master-slave system.



ECA information message:
'Application req. newer ECA':
The software (firmware) of your ECA does not comply with the software (firmware) of your ECL Comfort controller. Please contact your Danfoss sales office.

ECA 30 / 31 for ECL Comfort 210 / 210B / 296 / 310 / 310B



Some applications do not contain functions related to actual room temperature. The connected ECA 30 / 31 will only function as remote control.



Total cable length: Max. 200 m (all sensors incl. internal ECL 485 communication bus).
Cable lengths of more than 200 m may cause noise sensibility (EMC).

ECA 30 / 31 for ECL Comfort 210 / 210B / 296 / 310 / 310B

3.5 ECA 30 / 31 setup procedures

ECA 30 (code no. 087H3200) is a remote control unit with built-in room temperature sensor.

ECA 31 (code no. 087H3201) is a remote control unit with built-in room temperature sensor and humidity sensor (relative humidity).

An external room temperature sensor can be connected to both types to substitute the built-in sensor.

An external room temperature sensor will be recognized at ECA 30 / 31 power-up.

Connections: See the section 'Electrical connections'.

Max. two ECA 30 / 31 can be connected to one ECL controller or a system (master-slave) consisting of several ECL controllers connected on the same ECL 485 bus. In the master-slave system only one of the ECL controllers is master. The ECA 30 / 31 can, among others, be set to:

- monitor and set the ECL controller remotely
- measure the room temperature and (ECA 31) humidity
- extend comfort / saving period temporarily

After application upload in the ECL Comfort controller, the remote control unit ECA 30 / 31 will after approx. one minute ask to 'Copy application'.

Confirm this in order to upload the application to the ECA 30 / 31.

Menu structure

The menu structure of ECA 30 / 31 is an "ECA MENU" and the ECL menu, copied from the ECL Comfort controller.

The ECA MENU contains:

- ECA settings
- ECA system
- ECA factory

ECA settings: Offset adjustment of the measured room temperature.

Offset adjustment of relative humidity (ECA 31 only).

ECA system: Display, communication, override settings and version info.

ECA factory: Erase of all applications in the ECA 30 / 31, restore to factory settings, reset of ECL address and firmware update.

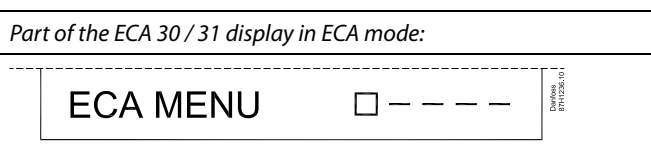
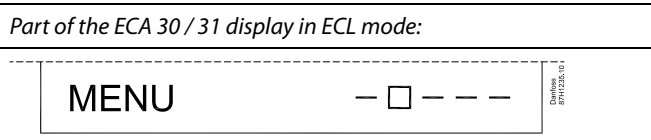

If only the "ECA MENU" is shown, it can indicate that the ECA 30 / 31 is not having correct communication address.
See ECA MENU > ECA system > ECA communication: ECL address.
In most cases the ECL address setting must be "15".



Regarding ECA settings:
When ECA 30 / 31 is not used as remote unit, the offset adjustments menu(s) are not present.

ECA 30 / 31 for ECL Comfort 210 / 210B / 296 / 310 / 310B

The ECL menus are as described for the ECL controller.

Most of the settings done directly in the ECL controller can be done via the ECA 30 / 31 too.



All settings can be seen even if the application key is not inserted in the ECL controller.
For changing settings, the application key must be inserted.

The Key overview (MENU > 'Common controller settings' > 'Key functions') does not show the applications of the key.



The ECA 30 / 31 will display this information (an X on the ECA 30 / 31 symbol) if the application in the ECL controller does not comply with the ECA 30 / 31:

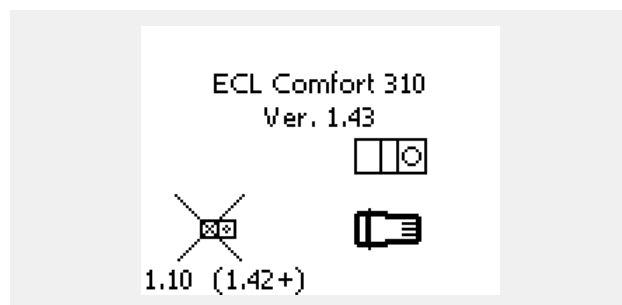

In the example 1.10 is current version and 1.42 is desired version.



Display part of ECA 30 / 31:

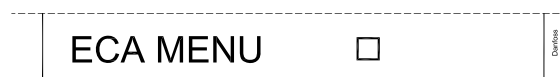

This display indicates that an application has not been uploaded or the communication to the ECL controller (master) is not working properly. An X on the ECL controller symbol indicates wrong setup of communication addresses.



Display part of ECA 30 / 31:



Newer versions of ECA 30 / 31 indicate the address number of the connected ECL Comfort controller.

Address number can be changed in the ECA MENU.

A stand-alone ECL Controller has the address 15.

ECA 30 / 31 for ECL Comfort 210 / 210B / 296 / 310 / 310B

When ECA 30 / 31 is in ECA MENU mode, the date and measured room temperature is displayed.

ECA MENU > ECA settings > ECA sensor

Room T Offset	
Setting range	Factory setting
-10.0 ... 10.0 K	0.0 K
<i>The measured room temperature can be corrected with a number of Kelvin. The corrected value is used by the heating circuit in the ECL controller.</i>	

Minus value: The indicated room temperature is lower.

0.0 K: No correction of the measured room temperature.

Plus value: The indicated room temperature is higher.

Example:	
Room T offset:	0.0 K
Displayed room temperature:	21.9 °C
Room T offset:	1.5 K
Displayed room temperature:	23.4 °C

ECA MENU > ECA settings > ECA sensor

RH offset (ECA 31 only)	
Setting range	Factory setting
-10.0 ... 10.0 %	0.0 %
<i>The measured relative humidity can be corrected with a number of %-values. The corrected value is used by the application in the ECL controller.</i>	

Minus value: The indicated relative humidity is lower.

0.0 %: No correction of the measured relative humidity.

Plus value: The indicated relative humidity is higher.

Example:	
RH offset:	0.0 %
Displayed relative humidity:	43.4 %
RH offset:	3.5 %
Displayed relative humidity:	46.9 %

ECA MENU > ECA system > ECA display

Backlight (display brightness)	
Setting range	Factory setting
0 ... 10	5
<i>Adjust the brightness of the display.</i>	

0: Weak backlight.

10: Strong backlight.

ECA 30 / 31 for ECL Comfort 210 / 210B / 296 / 310 / 310B

ECA MENU > ECA system > ECA display

Contrast (display contrast)	
Setting range	Factory setting
0 ... 10	3
<i>Adjust the contrast of the display.</i>	

- 0:** Low contrast.
10: High contrast.

ECA MENU > ECA system > ECA display

Use as remote	
Setting range	Factory setting
OFF / ON	*)
<i>ECA 30 / 31 can act as a simple or normal remote control for the ECL controller.</i>	

- OFF:** Simple remote control, no room temperature signal.
ON: Remote control, room temperature signal is available.
***):** Differently, depending on chosen application.



When set to OFF: The ECA menu shows date and time.

When set to ON: The ECA menu shows date and room temperature (and for ECA 31 relative humidity).

ECA MENU > ECA system > ECA communication

Slave addr. (Slave address)	
Setting range	Factory setting
A / B	A
<i>The setting of 'Slave addr.' is related to the setting 'ECA address' in the ECL controller. In the ECL controller it is selected from which ECA 30 / 31 unit the room temperature signal is received.</i>	

- A:** The ECA 30 / 31 has the address A.
B: The ECA 30 / 31 has the address B.



For installation of an application in an ECL Comfort 210 / 296 / 310 controller the 'Slave addr.' must be A.



If two ECA 30 / 31 are connected in the same ECL 485 bus system, the 'Slave addr.' must be "A" in the one ECA 30 / 31 unit and "B" in the other.

ECA 30 / 31 for ECL Comfort 210 / 210B / 296 / 310 / 310B

ECA MENU > ECA system > ECA communication

Connection addr. (Connection address)	
Setting range	Factory setting
1 ... 9 / 15	15
Setting of the address to which ECL controller the communication must run.	

1 .. 9: Slave controllers.

15: Master controller.



An ECA 30 / 31 can in an ECL 485 bus system (master – slave) be set to communicate, one by one, with all addressed ECL controllers.



Example:

Connection addr. = 15:	The ECA 30 / 31 communicates with the ECL master controller.
Connection addr. = 2:	The ECA 30 / 31 communicates with the ECL controller with address 2.



There must be a master controller present in order to broadcast time and date information.



An ECL Comfort controller 210 / 310, type B (without display and dial) cannot be assigned to the address 0 (zero).

ECA MENU > ECA system > ECA override

Override addr. (Override address)	
Setting range	Factory setting
OFF / 1 ... 9 / 15	OFF
The feature 'Override' (to extended comfort or saving period or holiday) must be addressed to the ECL controller in question.	

OFF: Override not possible.

1 .. 9: Address of slave controller for override.

15: Address of master controller for override.



Override functions:	Extended saving mode:	
	Extended comfort mode:	
	Holiday away from home:	
	Holiday at home:	



Override by means of settings in ECA 30 / 31 are cancelled if the ECL Comfort controller goes into holiday mode or is changed to another mode than scheduled mode.



The circuit in question for override in the ECL controller must be in scheduled mode.
See also the parameter 'Override circuit'.

ECA 30 / 31 for ECL Comfort 210 / 210B / 296 / 310 / 310B

ECA MENU > ECA system > ECA override

Override circuit	
Setting range	Factory setting
OFF / 1 ... 4	OFF
<i>The feature 'Override' (to extended comfort or saving period or holiday) must be addressed to the heating circuit in question.</i>	

OFF: No heating circuit is selected for override.

1 ... 4: The heating circuit number in question.



The circuit in question for override in the ECL controller must be in scheduled mode.
See also the parameter 'Override addr.'.



Example 1:

(One ECL controller and one ECA 30 / 31)		
Override of heating circuit 2:	Set 'Connection addr.' to 15	Set 'Override circuit' to 2

Example 2:

(Several ECL controllers and one ECA 30 / 31)		
Override of heating circuit 1 in ECL controller with the address 6:	Set 'Connection addr.' to 6	Set 'Override circuit' to 1



Quick guide "ECA 30 / 31 to override mode":

1. Go to ECA MENU
2. Move cursor to "Clock" symbol
3. Select the "Clock" symbol
4. Choose and select one of 4 override functions
5. Below the override symbol: Set hours or date
6. Below hours / date: Set desired room temperature for the override period

ECA MENU > ECA system > ECA version

ECA version (read-out only), examples	
Code no.	087H3200
Hardware	A
Software	1.42
Build no.	5927
Serial no.	13579
Production week	23.2012



ECA 30 / 31:

15	Connection address (master: 15, slaves: 1 - 9)
----	--

The ECA version information is useful in service situations.

ECA 30 / 31 for ECL Comfort 210 / 210B / 296 / 310 / 310B

ECA MENU > ECA factory > ECA clear apps.

Erase all apps. (Erase all applications)

*Erase all applications which are in the ECA 30 / 31.
After erasing, the application can be uploaded again.*

NO: The erase procedure is not done.

YES: The erase procedure is done (await 5 sec.).



After the erase procedure, a pop-up in the display indicates "Copy application". Choose "Yes". Hereafter the application is uploaded from the ECL controller. An upload bar is shown.

ECA MENU > ECA factory > ECA default

Restore factory

The ECA 30 / 31 is set back to factory settings.

Affected settings by the restore procedure:

- Room T offset
- RH offset (ECA 31)
- Backlight
- Contrast
- Use as remote
- Slave addr.
- Connection addr.
- Override addr.
- Override circuit
- Override mode
- Override mode end time

NO: The restore procedure is not done.

YES: The restore procedure is done.

ECA 30 / 31 for ECL Comfort 210 / 210B / 296 / 310 / 310B

ECA MENU > ECA factory > Reset ECL addr.

Reset ECL addr. (Reset ECL address)

If none of the connected ECL Comfort controllers has the address 15, the ECA 30 / 31 can set all connected ECL controllers on the ECL 485 bus back to address 15.

NO: The reset procedure is not done.

YES: The reset procedure is done (await 10 sec.).



The ECL 485 bus related address of the ECL controller is found:
MENU > 'Common controller settings' > 'System' > 'Communication' > 'ECL 485 addr'.



The "Reset ECL addr." cannot be activated if one or more of the connected ECL Comfort controllers has the address 15.



In a system with MASTER / SLAVE controllers, only one MASTER controller with address 15 is allowed.

If by mistake more MASTER controllers are present in an ECL 485 communication bus system, decide which controller is to be MASTER. Change the address in the remaining controllers. However, the system will operate but not be stable with more than one MASTER controller.

ECA MENU > ECA factory > Update firmware

Update firmware

The ECA 30 / 31 can be updated with new firmware (software). .
The firmware comes with the ECL application key, when the key version is at least 2.xx.
If no new firmware is available, a symbol of the application key is displayed with an X.

NO: The updating procedure is not done.

YES: The updating procedure is done.



The ECA 30 / 31 automatically verifies if a new firmware is present on the application key in the ECL Comfort controller.

The ECA 30 / 31 is automatically updated at new application upload in the ECL Comfort controller.

The ECA 30 / 31 is not automatically updated when connected to an ECL Comfort controller with uploaded application. A manual update is always possible.





4.0 Settings

4.1 Room temperature

Setting the desired room temperature, ECA 30 / ECA 31

The desired room temperature can be set exactly as in the controller. However, other symbols can be present in the display (please see 'What do the symbols mean?').



With the ECA 30 / ECA 31 you can override the desired room temperature set in the controller temporarily by means of the override functions:    

ECA 30 / 31 for ECL Comfort 210 / 210B / 296 / 310 / 310B

4.2 Optimization

MENU > Settings > Optimization

Boost		11012
Circuit	Setting range	Factory setting
	OFF / 1 ... 99%	OFF
<i>Shortens the heating-up period by increasing the desired flow temperature by the percentage you set.</i>		

OFF: The boost function is not active.

1-99%: The desired flow temperature is increased temporarily with the set percentage.

In order to shorten the heating-up period after a saving temperature period, the desired flow temperature can be increased temporarily (max. 1 hour). At optimizing the boost is active in the optimization period ('Optimizer').





If a room temperature sensor or an ECA 30 / 31 is connected, the boost stops when the room temperature is reached.

ECA 30 / 31 for ECL Comfort 210 / 210B / 296 / 310 / 310B

4.3 Holiday

The ECA 30 / 31 cannot override the holiday schedule of the controller temporarily.

However, it is possible to make use of the following options from the ECA 30 / 31 when the controller is in scheduled mode:

-  Day off
-  Holiday
-  Relaxing (extended comfort period)
-  Going out (extended saving period)



Energy-saving trick:
Use 'Going out' (the extended saving period) for airing purposes (e.g. for ventilating the rooms by means of fresh air from open windows).



Quick guide "ECA 30 / 31 to override mode":

1. Go to ECA MENU
2. Move cursor to "Clock" symbol
3. Select the "Clock" symbol
4. Choose and select one of 4 override functions
5. Below the override symbol: Set hours or date
6. Below hours / date: Set desired room temperature for the override period

ECA 30 / 31 for ECL Comfort 210 / 210B / 296 / 310 / 310B

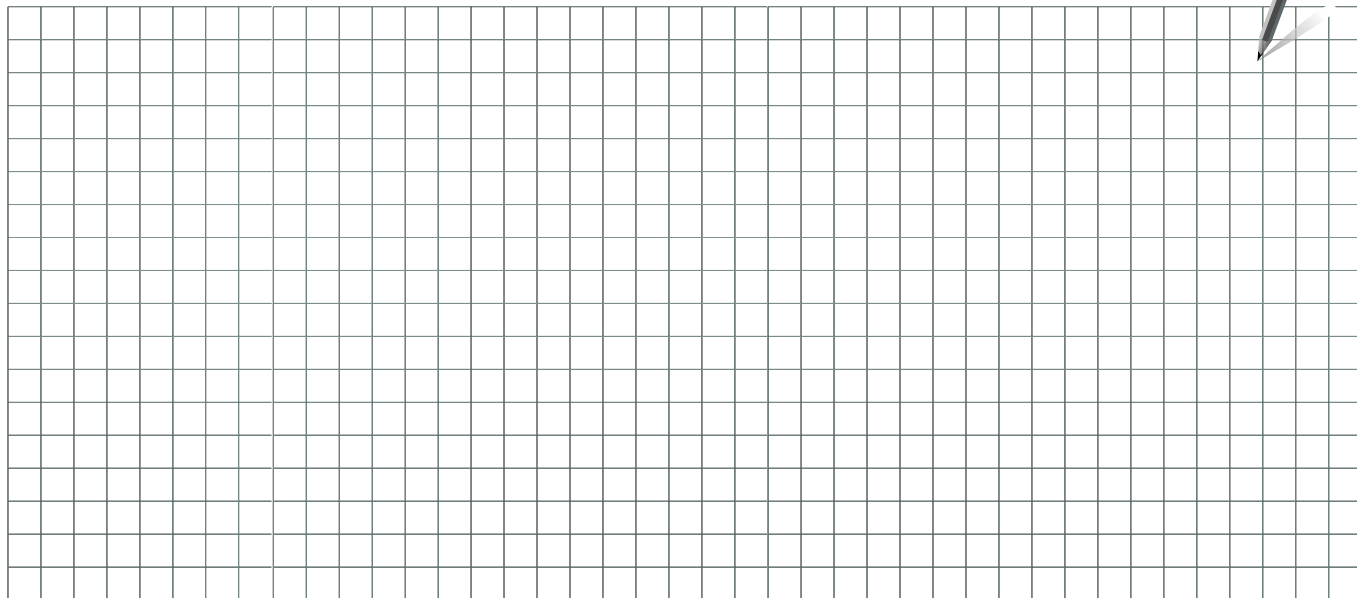

Installer:
By:
Date:

ECA 30 / 31 for ECL Comfort 210 / 210B / 296 / 310 / 310B



Danfoss A/S
Heating Segment • heating.danfoss.com • +45 7488 2222 • E-Mail: heating@danfoss.com

Danfoss can accept no responsibility for possible errors in catalogues, brochures and other printed material. Danfoss reserves the right to alter its products without notice. This also applies to products already on order provided that such alterations can be made without subsequential changes being necessary in specifications already agreed.
All trademarks in this material are property of the respective companies. Danfoss and all Danfoss logotypes are trademarks of Danfoss A/S. All rights reserved.